

IN74AC323

**8-Bit Bidirectional Universal
Shift Register with Parallel I/O
High-Speed Silicon-Gate CMOS**

The IN74AC323 is identical in pinout to the LS/ALS323, HC/HCT323. The device inputs are compatible with standard CMOS outputs; with pullup resistors, they are compatible with LS/ALS outputs.

The IN74AC323 features a multiplexed parallel input/output data port to achieve full 8-bit handling in a 20 pin package. Due to the large output drive capability and the 3-state feature, this device is ideally suited for interface with bus lines in a bus-oriented system.

Two Mode-Select inputs and two Output Enable inputs are used to choose the mode of operation as listed in the Function Table. Synchronous parallel loading is accomplished by taking both Mode-Select lines, S₁ and S₂, high. This places the outputs in the high-impedance state, which permits data applied to the data port to be clocked into the register. Reading out of the register can be accomplished when the outputs are enabled. The active-low synchronous Reset overrides all other inputs.

- Outputs Directly Interface to CMOS, NMOS, and TTL
- Operating Voltage Range: 2.0 to 6.0 V
- Low Input Current: 1.0 μA; 0.1 μA @ 25°C
- High Noise Immunity Characteristic of CMOS Devices
- Outputs Source/Sink 24 mA

LOGIC DIAGRAM

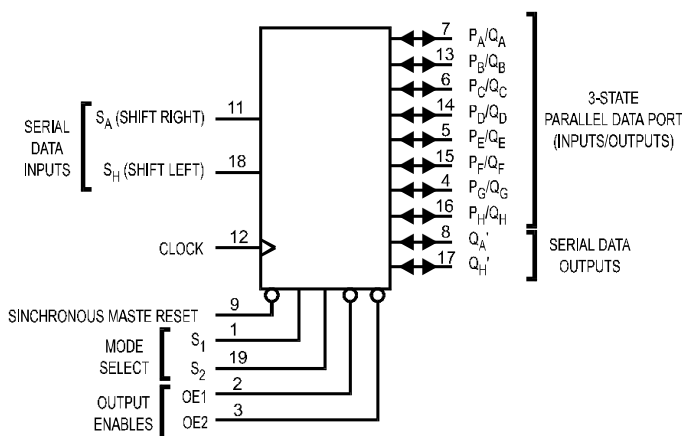

PIN 20 = V_{CC}
PIN 10 = GND

ORDERING INFORMATION
IN74AC323N Plastic
IN74AC323DW SOIC
T_A = -40° to 85° C for all packages

PIN ASSIGNMENT

S1	1 ●	20	V _{CC}
OE1	2	19	S2
OE2	3	18	S _H
PG/QG	4	17	Q _H '
PE/QE	5	16	P _H /Q _H
PC/QC	6	15	P _F /Q _F
PA/QA	7	14	P _D /Q _D
Q _A '	8	13	P _B /Q _B
RESET	9	12	CLOCK
GND	10	11	S _A

MAXIMUM RATINGS*

Symbol	Parameter	Value	Unit
V _{CC}	DC Supply Voltage (Referenced to GND)	-0.5 to +7.0	V
V _{IN}	DC Input Voltage (Referenced to GND)	-0.5 to V _{CC} +0.5	V
V _{OUT}	DC Output Voltage (Referenced to GND)	-0.5 to V _{CC} +0.5	V
I _{IN}	DC Input Current, per Pin	±20	mA
I _{OUT}	DC Output Sink/Source Current, per Pin	±50	mA
I _{CC}	DC Supply Current, V _{CC} and GND Pins	±50	mA
P _D	Power Dissipation in Still Air, Plastic DIP+ SOIC Package+	750 500	mW
T _{stg}	Storage Temperature	-65 to +150	°C
T _L	Lead Temperature, 1 mm from Case for 10 Seconds (Plastic DIP or SOIC Package)	260	°C

*Maximum Ratings are those values beyond which damage to the device may occur. Functional operation should be restricted to the Recommended Operating Conditions.

+Derating - Plastic DIP: - 10 mW/°C from 65° to 125°C
SOIC Package: : - 7 mW/°C from 65° to 125°C

RECOMMENDED OPERATING CONDITIONS

Symbol	Parameter	Min	Max	Unit	
V _{CC}	DC Supply Voltage (Referenced to GND)	2.0	6.0	V	
V _{IN} , V _{OUT}	DC Input Voltage, Output Voltage (Referenced to GND)	0	V _{CC}	V	
T _J	Junction Temperature (PDIP)		140	°C	
T _A	Operating Temperature, All Package Types	-40	+85	°C	
I _{OH}	Output Current - High		-24	mA	
I _{OL}	Output Current - Low		24	mA	
t _r , t _f	Input Rise and Fall Time * (except Schmitt Inputs)	V _{CC} = 3.0 V V _{CC} = 4.5 V V _{CC} = 5.5 V	0 0 0	150 40 25	ns/V

*V_{IN} from 30% to 70% V_{CC}

This device contains protection circuitry to guard against damage due to high static voltages or electric fields. However, precautions must be taken to avoid applications of any voltage higher than maximum rated voltages to this high-impedance circuit. For proper operation, V_{IN} and V_{OUT} should be constrained to the range GND ≤ (V_{IN} or V_{OUT}) ≤ V_{CC}.

Unused inputs must always be tied to an appropriate logic voltage level (e.g., either GND or V_{CC}). Unused outputs must be left open.

DC ELECTRICAL CHARACTERISTICS(Voltages Referenced to GND)

Symbol	Parameter	Test Conditions	V _{CC} V	Guaranteed Limits		Unit	
				25 °C	-40°C to 85°C		
V _{IH}	Minimum High-Level Input Voltage	V _{OUT} =0.1 V or V _{CC} -0.1 V	3.0	2.1	2.1	V	
			4.5	3.15	3.15		
			5.5	3.85	3.85		
V _{IL}	Maximum Low - Level Input Voltage	V _{OUT} =0.1 V or V _{CC} -0.1 V	3.0	0.9	0.9	V	
			4.5	1.35	1.35		
			5.5	1.65	1.65		
V _{OH}	Minimum High-Level Output Voltage	I _{OUT} ≤ -50 μA	3.0	2.9	2.9	V	
			4.5	4.4	4.4		
			5.5	5.4	5.4		
		*V _{IN} = V _{IH} or V _{IL}					
		I _{OH} = -12 mA	3.0	2.56	2.46		
I _{OH} = -24 mA	4.5	3.86	3.76				
I _{OH} = -24 mA	5.5	4.86	4.76				
V _{OL}	Maximum Low-Level Output Voltage	I _{OUT} ≤ 50 μA	3.0	0.1	0.1	V	
			4.5	0.1	0.1		
			5.5	0.1	0.1		
		*V _{IN} = V _{IH} or V _{IL}					
		I _{OL} = 12 mA	3.0	0.36	0.44		
I _{OL} = 24 mA	4.5	0.36	0.44				
I _{OL} = 24 mA	5.5	0.36	0.44				
I _{IN}	Maximum Input Leakage Current	V _{IN} = V _{CC} or GND	5.5	±0.1	±1.0	μA	
I _{OZ}	Maximum Three-State Leakage Current	V _{IN} (OE) = V _{IH} or V _{IL} V _{IN} = V _{CC} or GND V _{OUT} = V _{CC} or GND	5.5	±0.6	±6.0	μA	
I _{OLD}	+Minimum Dynamic Output Current	V _{OLD} = 1.65 V Max	5.5		75	mA	
I _{OHD}	+Minimum Dynamic Output Current	V _{OHD} = 3.85 V Min	5.5		-75	mA	
I _{CC}	Maximum Quiescent Supply Current (per Package)	V _{IN} = V _{CC} or GND	5.5	8.0	80	μA	

* All outputs loaded; thresholds on input associated with output under test.

+Maximum test duration 2.0 ms, one output loaded at a time.

Note: I_{IN} and I_{CC} @ 3.0 V are guaranteed to be less than or equal to the respective limit @ 5.5 V V_{CC}

AC ELECTRICAL CHARACTERISTICS($C_L=50\text{pF}$, Input $t_r=t_f=3.0\text{ ns}$)

Symbol	Parameter	V _{CC} [*] V	Guaranteed Limits				Unit
			25 °C		-40°C to 85°C		
			Min	Max	Min	Max	
f _{max}	Maximum Clock Frequency (Figure 1)	3.3 5.0	90 130		80 105		MHz
t _{PLH}	Propagation Delay, Clock to Q _A ' or Q _H ' (Figure 1)	3.3 5.0	8.5 5.5	20.5 14.0	7.0 4.5	22.0 15.0	ns
t _{PHL}	Propagation Delay, Clock to Q _A ' or Q _H ' (Figure 1)	3.3 5.0	8.5 5.5	21.5 14.5	7.0 5.0	23.0 16.0	ns
t _{PLH}	Propagation Delay, Clock to Q _A thru Q _H (Figure 1)	3.3 5.0	9.0 6.0	20.5 14.5	7.5 5.0	22.5 16.0	ns
t _{PHL}	Propagation Delay, Clock to Q _A thru Q _H (Figure 1)	3.3 5.0	10.0 6.5	23.0 16.0	8.5 6.0	24.5 17.5	ns
t _{PZH}	Propagation Delay , OE1, OE2 to Q _A thru Q _H (Figure 3)	3.3 5.0	7.0 4.5	18.0 12.5	6.0 4.0	19.5 13.5	ns
t _{PZL}	Propagation Delay , OE1, OE2 to Q _A thru Q _H (Figure 3)	3.3 5.0	7.0 5.0	18.0 12.5	6.0 4.0	20.5 14.0	ns
t _{PHZ}	Propagation Delay , OE1, OE2 to Q _A thru Q _H (Figure 3)	3.3 5.0	6.5 3.5	18.5 14.0	5.5 3.0	19.5 15.0	ns
t _{PLZ}	Propagation Delay , OE1, OE2 to Q _A thru Q _H (Figure 3)	3.3 5.0	5.5 3.5	17.0 12.5	4.5 2.0	19.0 13.5	ns
C _{IN}	Maximum Input Capacitance	5.0	4.5		4.5		pF

C _{PD}	Power Dissipation Capacitance	Typical @25°C, V _{CC} =5.0 V		pF
		170		

*Voltage Range 3.3 V is 3.3 V ±0.3 V

Voltage Range 5.0 V is 5.0 V ±0.5 V









TIMING REQUIREMENTS($C_L=50\text{pF}$, Input $t_r=t_f=3.0\text{ ns}$)

Symbol	Parameter	V _{CC} * V	Guaranteed Limits		Unit
			25 °C	-40°C to 85°C	
t _{su}	Minimum Setup Time, Mode Select S1 or S2 to Clock (Figure 4)	3.3 5.0	8.0 5.0	8.5 5.5	ns
t _{su}	Minimum Setup Time, Data Inputs P _A thru P _H to Clock (Figure 4)	3.3 5.0	5.5 3.5	6.0 4.0	ns
t _{su}	Minimum Setup Time, Data Inputs S _A , S _H to Clock (Figure 4)	3.3 5.0	6.5 4.0	7.0 4.5	ns
t _{su}	Minimum Setup Time, Reset to Clock (Figure 2)	3.3 5.0	6.5 4.0	7.0 4.5	ns
t _h	Minimum Hold Time, Clock to Mode Select S1 or S2 (Figure 4)	3.3 5.0	0.5 1.0	0.5 1.0	ns
t _h	Minimum Hold Time, Clock to Data Inputs P _A thru P _H (Figure 4)	3.3 5.0	0 1.0	0 1.0	ns
t _h	Minimum Hold Time, Clock to Data Inputs S _A , S _H (Figure 4)	3.3 5.0	0 1.0	0.5 1.0	ns
t _h	Minimum Hold Time, Clock to Reset (Figure 2)	3.3 5.0	0 1.0	0 1.0	ns
t _w	Minimum Pulse Width, Clock (Figure 1)	3.3 5.0	4.5 3.5	5.0 3.5	ns
t _w	Minimum Pulse Width, Reset (Figure 2)	3.3 5.0	4.5 3.5	5.0 3.5	ns

*Voltage Range 3.3 V is 3.3 V ±0.3 V

Voltage Range 5.0 V is 5.0 V ±0.5 V

FUNCTION TABLE

Inputs									Response									
Mode	Reset	Mode Select		Output Enables		Clock	Serial Inputs		P _A / Q _A	P _B / Q _B	P _C / Q _C	P _D / Q _D	P _E / Q _E	P _F / Q _F	P _G / Q _G	P _H / Q _H	Q _A '	Q _H '
		S ₂	S ₁	OE1 [↑]	OE2 [↑]		D _A	D _H										
Reset	L	X	L	L	L		X	X	L	L	L	L	L	L	L	L	L	L
	L	L	X	L	L		X	X	L	L	L	L	L	L	L	L	L	L
	L	H	H	X	X	X	X	X	Q _A through Q _H =Z								L	L
Shift Right	H	L	H	H	X		D	X	Shift Right: Q _A through Q _H =Z; D _A → F _A ; F _A → F _B ; etc								D	Q _G
	H	L	H	X	H		D	X	Shift Right: Q _A through Q _H =Z; D _A → F _A ; F _A → F _B ; etc								D	Q _G
	H	L	H	L	L		D	X	Shift Right: D _A → F _A = Q _A ; F _A → F _B = Q _B ; etc								D	Q _G
Shift Left	H	H	L	H	X		X	D	Shift Left: Q _A through Q _H =Z; D _H → F _H ; F _H → F _G ; etc								Q _B	D
	H	H	L	X	H		X	D	Shift Left: Q _A through Q _H =Z; D _H → F _H ; F _H → F _G ; etc								Q _B	D
	H	H	L	L	L		X	D	Shift Left: D _H → F _H = Q _H ; F _H → F _G = Q _G ; etc								Q _B	D
Parallel Load	H	H	H	X	X		X	X	Parallel Load: P _N → F _N								P _A	P _H
Hold	H	L	L	H	X	X	X	X	Hold: Q _A through Q _H =Z; F _N =F _N								P _A	P _H
	H	L	L	X	H	X	X	X	Hold: Q _A through Q _H =Z; F _N =F _N								P _A	P _H
	H	L	L	L	L	X	X	X	Hold: Q _N = Q _H								P _A	P _H

Z = high impedance

D = data on serial input

F = flip-flop (see Logic Diagram)

[↑] When one or both output controls are high the eight input/output terminals are disabled to the high-impedance state; however, sequential operation or clearing of the register is not affected.

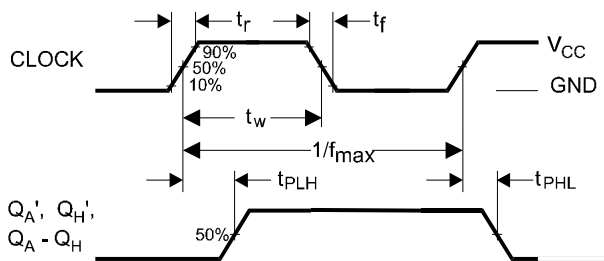

Figure 1. Switching Waveform

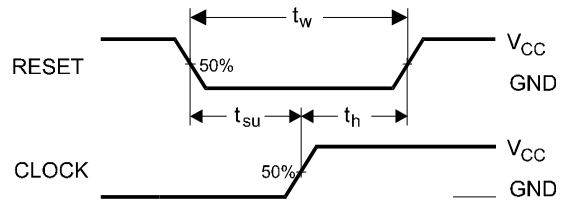

Figure 2. Switching Waveform

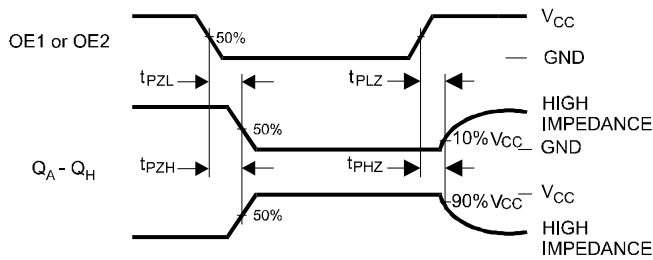

Figure 3. Switching Waveform

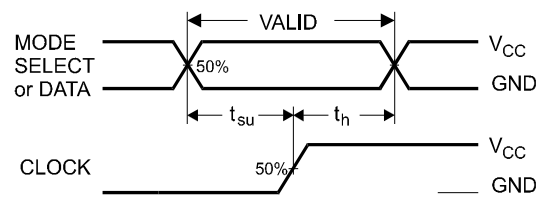

Figure 4. Switching Waveform

EXPANDED LOGIC DIAGRAM

